

NV1... / TN1.. / M..

Armement nappe voûte

Domaine d'application : HTA

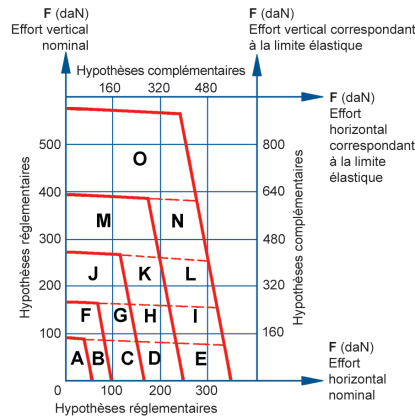
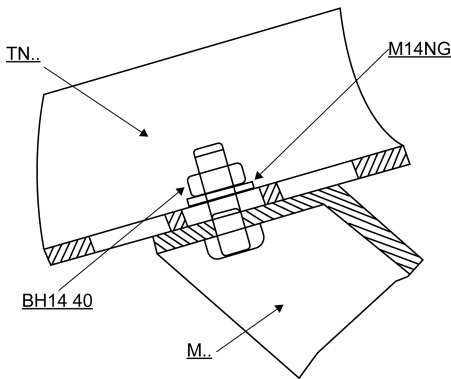
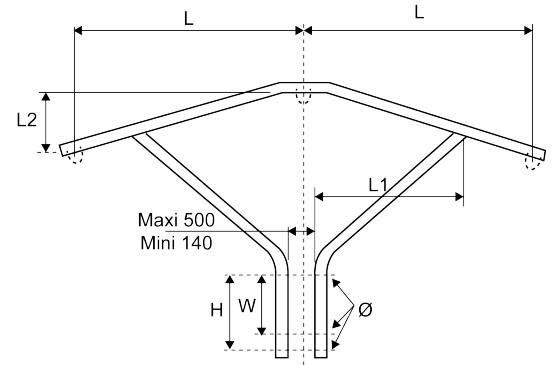

Zone	Cornière	Zone	Cornière
A	50 x 50	I	60 x 90
B	50 x 60	J	70 x 70
C	50 x 70	K	70 x 80
D	50 x 80	L	70 x 90
E	50 x 90	M	80 x 80
F	60 x 60	N	80 x 90
G	60 x 70	O	90 x 90
H	60 x 80		

Réf.	Réf. Enedis	Code Enedis	Dimensions	Poids (kg)	Composition
------	-------------	-------------	------------	------------	-------------

			Longueur L (mm)	Longueur L1 (mm)	Longueur L2 (mm)	Largeur W (mm)	Hauteur H (mm)	Dimension entre les câbles U (mm)	Diamètre Ø (mm)		
NV1 80 80	NV1 80 80	6857244	1500	930	418	420	490	80	16	68	1 x <u>TN1 80</u> / 2 x <u>M80</u> / 2 x <u>BH14 40</u> / 2 x <u>M14NG</u>

U = cornière