

## NV2... / TN2.. / M..

### Armement nappe voûte

Domaine d'application : HTA

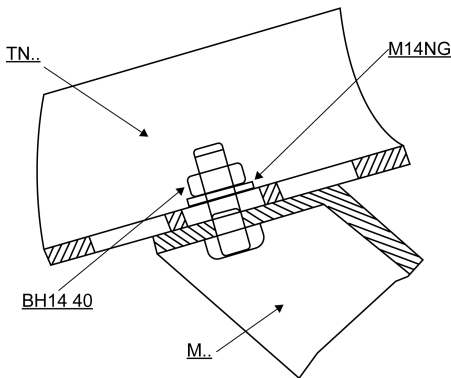
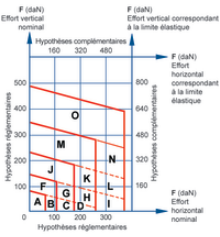
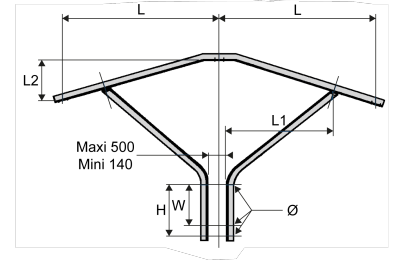

Zone	Cornière	Zone	Cornière
A	50 x 50	I	60 x 90
B	50 x 60	J	70 x 70
C	50 x 70	K	70 x 80
D	50 x 80	L	70 x 90
E	50 x 90	M	80 x 80
F	60 x 60	N	80 x 90
G	60 x 70	O	90 x 90
H	60 x 80		

Réf.	Réf. Enedis	Code Enedis	Dimensions						Poids (kg)	Composition
			Longueur L (mm)	Longueur L1 (mm)	Longueur L2 (mm)	Largeur W (mm)	Hauteur H (mm)	Diamètre Ø (mm)		
<b>NV27080</b>	NV2 70 80	6857277	1700	930	480	420	490	16	64	<b>1 x TN2 70 / 2 x M80 / 2 x BH14 40 / 2 x M14NG</b>

U = cornière